

# INFO RAIL +

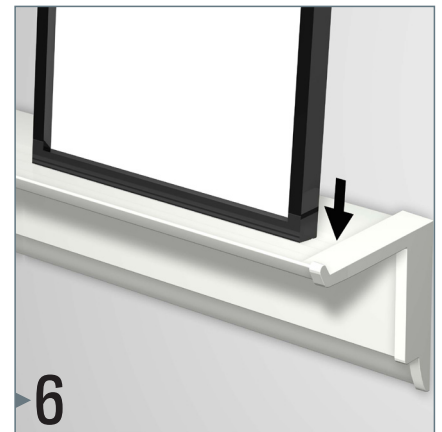

3 CLIPS/m -  $>80g < 2mm$  - 5kg max

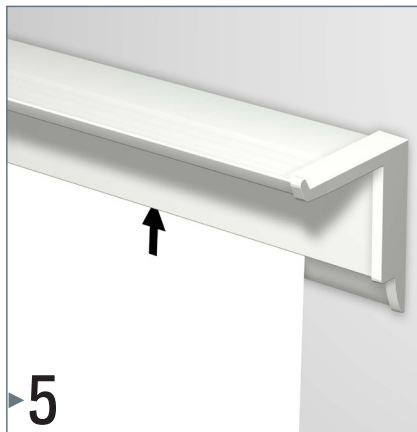
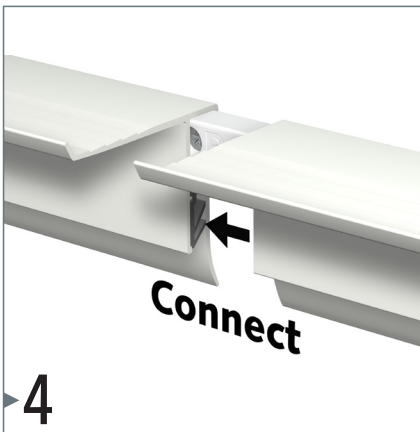
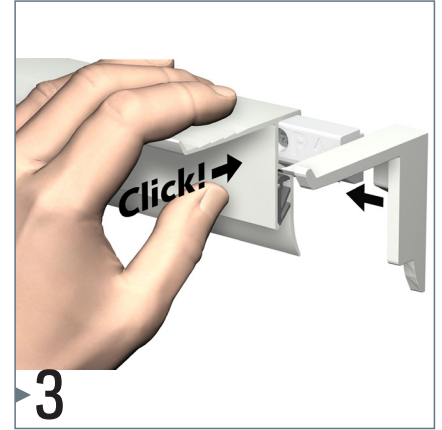
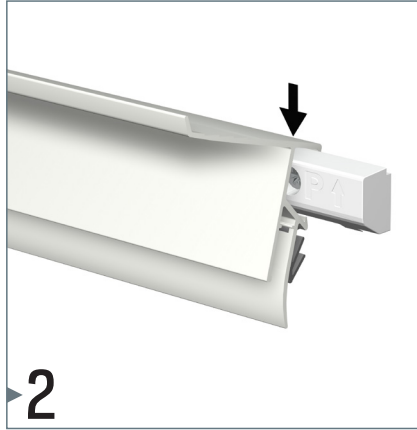
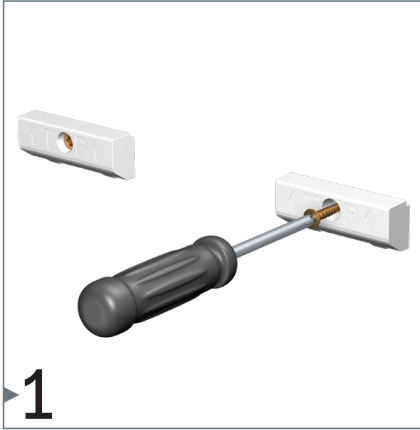

installation video:



FLEXIBLE  
SAFE  
STRONG

# INFO RAIL + >80g <2mm - 5kg max

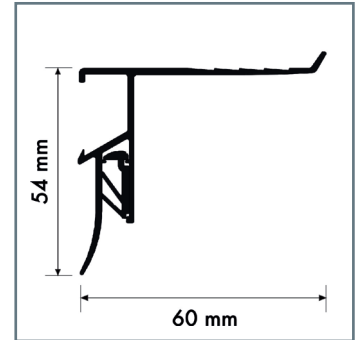
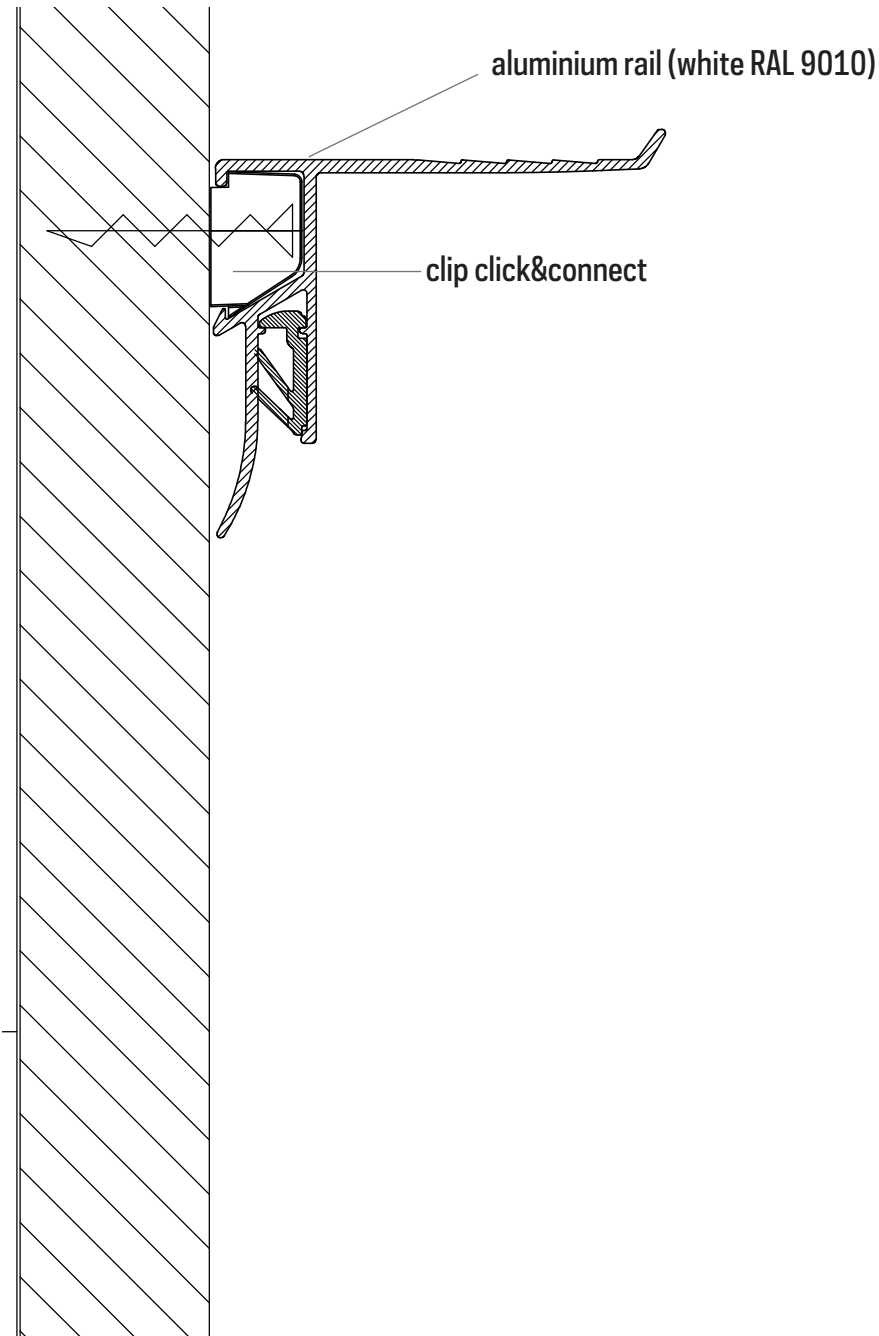

SCALE 1:1

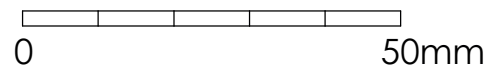

Installation video:



ARTITEQ  
HERASTRAAT 39  
5047 TX TILBURG (NL)  
T +31 (0)13 572 90 70  
info@artiteq.com

